

User's Guide

CSRFB10xx-100

Slide-in-Module Media Converter

- **Copper to Fiber**
- **10/100 Bridging (2-Port)**
- **10Base-T/100Base-TX to 100Base-FX**

The CSRFB10xx-100, 2-port Ethernet/Fast Ethernet bridging media converter is designed to be installed in a Transition Networks *PointSystem*™ chassis. This converter connects 10Base-T Ethernet or 100Base-TX Fast Ethernet twisted-pair copper network converters

to network converters on a 100Base-FX Fast Ethernet fiber network. The CSRFB includes a status reporting feature for viewing operational parameters only from its remotely attached CSRFB converter via the fiber connection.

Part Number	Port One - Copper 10Base-T/100Base-TX	Port Two - Duplex Fiber-Optic 100Base-FX
CSRFB1011-100	RJ-45 100 m (328 ft)*	ST, 1310nm multimode 2 km (1.2 miles)*
CSRFB1013-100	RJ-45 100 m (328 ft)*	SC, 1310 nm multimode 2 km (1.2 miles)
CSRFB1014-100	RJ-45 100 m (328 ft)*	SC, 1310 nm single mode 20 km (12.4 miles)
CSRFB1040-100	RJ-45 100 m (328 ft)*	SFP Empty Slot
CSRFB1029-100	RJ-45 100 m (328 ft)*	SC, 1310nmTX/1550nmRX 20km (12.4 miles)
CSRFB1029-101	RJ-45 100 m (328 ft)*	SC, 1550nmTX/1310nmRX 20km (12.4 miles)
CSRFB1029-102	RJ-45 100 m (328 ft)*	SC, 1310nmTX/1550nmRX 40km (24.9 miles)
CSRFB1029-103	RJ-45 100 m (328 ft)*	SC, 1550nmTX/1310nmRX 40km (24.9 miles)

Install CSRFB1029-100/101 and CSRFB1029-102/103 single-fiber optic in the same network where one is the local (*center*) converter and the other is the remote (*terminal*) converter.

Installation	2
Operation	7
Cable Specifications	11
Technical Specifications	12
Troubleshooting	13
Contact Us	15
Compliance Information	16

Installation

CAUTION: Wear a grounding converter and observe electrostatic discharge precautions while handling the media converter. Failure to observe this caution could result in damage to or failure of the media converter.

Typical system configuration

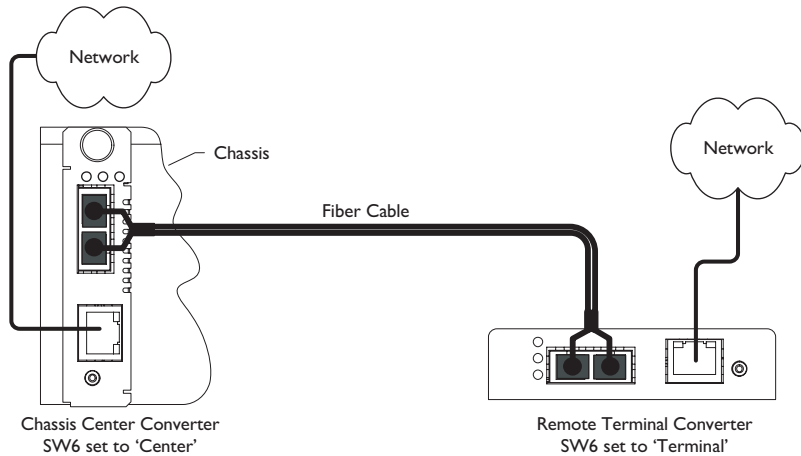

Note: The Loopback test occurs over the fiber connection.

The 6-position switch

- The 6-position switch is located on the side of the media converter.
- Use a small flat blade screwdriver or a similar device to set the recessed switches.
- Refer to the drawing to the right for definitions of the individual switch positions.

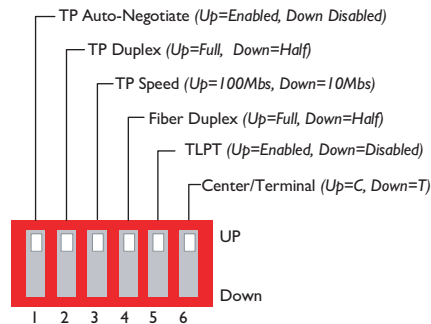

- TP Auto-Negotiation
 - up Enables
 - down Disables
- TP Duplex (Only valid if SW1 is Down)
 - up Full
 - down Half

Installation -- Continued

The 6-position switch--continued

- TP Speed (Only valid if SW1 is Down)
 - up 100Mbps
 - down 10Mbps
- Fiber Duplex
 - up Forces full duplex operation on the fiber port.
 - down Forces half duplex operation on the fiber port.
- Transparent Link Pass Through (TLPT)
 - up Enabled
 - down Disabled
- Center/Terminal Mode (see note)
 - up Center mode (center converter only)
 - down Terminal mode (terminal converter only)

Note: To use the TS1000 compliant Center/Terminal mode function, set SW6 on the center converter in the chassis to Center Mode, the (UP) position; on the terminal converter at the remote location, set SW6 to Terminal Mode, the (DOWN) position. This allows you to view parameters of the terminal converter from the center converter for monitoring purposes only .

Hardware/software mode jumper

The jumpers are located on the media converter circuit board. Use small needle-nosed pliers or a similar converter to set the jumper.

The Hardware/Software jumper is labeled “H” for hardware and “S” for software.

Hardware The media converter mode is determined by the settings on the 6-position switch.

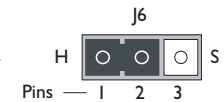

Software The media converter mode is determined by the most recently saved, on-board microprocessor settings.



Note: Software Mode only when the SW6 of the chassis converter is in the UP position (center).

Installation -- Continued

AutoCross jumper

The AutoCross jumper is located on the media converter's circuit board (*labeled NA = No Autocross; A = AutoCross*). See Jumper position below.

Note: Use small needle-nose pliers to set the jumper.

A Either straight-through or crossover cable can be used for all twisted-pair copper links.

NA Straight-through or crossover twisted-pair cable, depending on installed site converters, **MUST** be installed at EACH twisted-pair copper link.

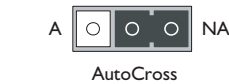
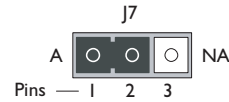

Note: Factory default is "A" enabled. Transition Networks recommends leaving the converter in the "A" enabled position.

The Loopback Mode jumper is located on the media converter's circuit board (*labeled ALL= all frames plus errors, Good = Good frames only*). See Jumper position to the right.

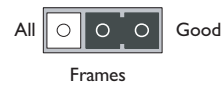
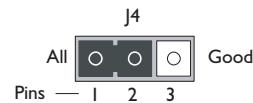

Loopback test

The loopback test is an automatic test run from the center chassis converter with SW6 set to 'center,' the UP position of the switch; and on the terminal converter with SW6 set to 'terminal,' the DOWN position of the switch.

Note: This test is self-running after being initiated through software on the center converter.

The Loopback test does the following:

1. The center converter will put the terminal converter in loopback mode.
2. The center converter sends 100 packets to the terminal converter.
3. The center converter will monitor its receiver for:
 - a. good packets
 - b. CRC errors
 - c. timeouts
4. After the center converter receives all 100 packets back or a time out occurs, it will update its counters and return the terminal converter to its previous mode of operation.

After completing the test, normal operation of the center and terminal converters is established automatically.

Install the slide-in-module

To install the CSRFB10xx-100 media converter slide-in-module:

1. Locate an empty installation slot on the *PointSystem™* chassis.
2. Carefully slide the module into the slot, aligning the module with the installation guides.
3. Ensure that the module is firmly seated inside the chassis.
4. Push in and rotate the panel fastener screw to secure the module to the chassis front.

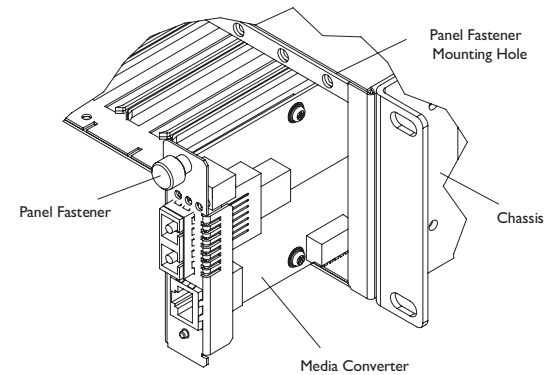

Installation -- Continued

Install the twisted-pair copper cable

1. Locate IEEE 803.2 compliant 10Base-T or 100Base-TX cable with RJ-45 connectors installed on both ends.
2. Connect the RJ-45 connector at one end of the cable to the RJ-45 port connector on the media converter.
3. Connect the RJ-45 connector at the other end of the cable to the RJ-45 port connector on the other converter (*switch, workstation, etc.*).

Note: The MDI (*straight-through*) or MDI-X (*crossover*) cable connection is configured automatically, when the AutoCross jumper is in the enabled position.

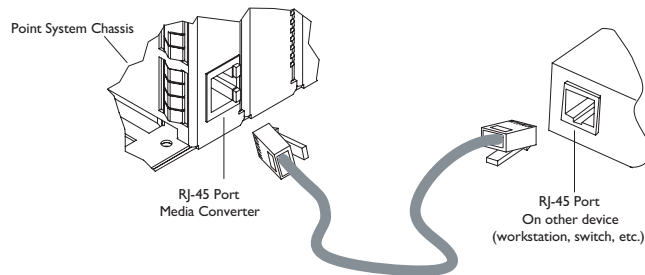

Install the fiber cable

1. Locate or build IEEE 803.2™ compliant 100Base-FX fiber cable with male, two-stranded TX to RX connectors installed at both ends.
2. Connect the fiber cables to the CSRFB10xx-100 media converter as described:
 - Connect the male TX cable connector to the female TX connector.
 - Connect the male RX cable connector to the female RX connector.
3. Connect the fiber cables to the other converter (*media converter, hub, etc.*) as described:
 - Connect the male TX cable connector to the female RX connector.
 - Connect the male RX cable connector to the female TX connector.

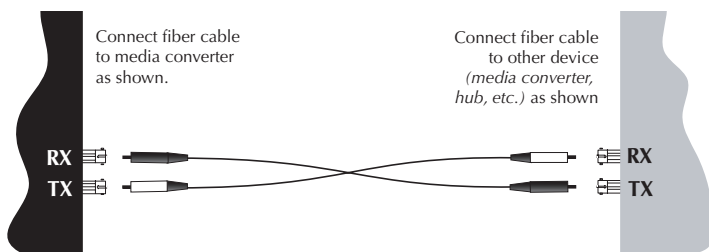

Operation

Status LEDs

LED	Description
Power	ON = Power OFF = No power
Fiber LEDs	
Link/Activity	Green ON Solid = Link, OFF = no link Green Blink = Activity
Duplex (FD)	Green ON = Full Duplex OFF = Half Duplex
Copper LEDs	
Link/Activity (LED2)	Green ON Solid = Link, Blink = Activity Blink = Rx Data
Duplex (LED2)	Green ON = Full Duplex, Blink = Activity Yellow ON = Half Duplex, Blink = Activity
Speed (LED1)	Green=100 Mbps Yellow =10 Mbps

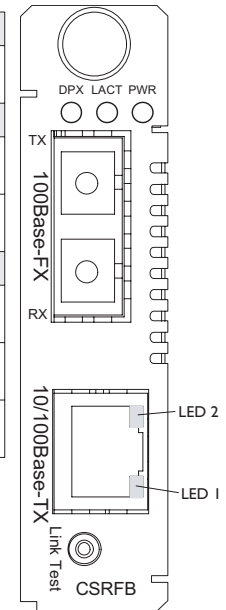

Product Features

Link Test button

Press the Link Test button to bypass TLPT when enabled.

Note: This is a momentary override button; when released, the connection will return to its previous state.

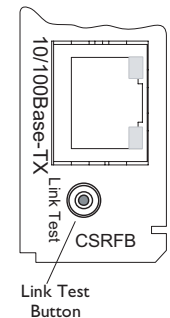

AutoCross™

The AutoCross feature detects and configures the twisted-pair copper port on the CSRFB10xx-100 media converter to the correct straight-through (MDI) or crossover (MDI-X) configuration. This feature allows either MDI or MDI-X cable to connect the media converter to converters such as hubs, transceivers, or network interface cards (NICs). (*This feature does not require operator intervention.*)

Operation -- Continued

Product features -- continued

Transparent link pass-through (TLPT)

TLPT notifies the end converter of a link failure by sending a link-loss signal over the fiber, instructing the terminal converter to shut down the copper port thus notifying the end converter. The fiber link between the two converters will be maintained.

- End converter automatically notified of link loss
- Fiber link remains up as it carries the link-loss signal

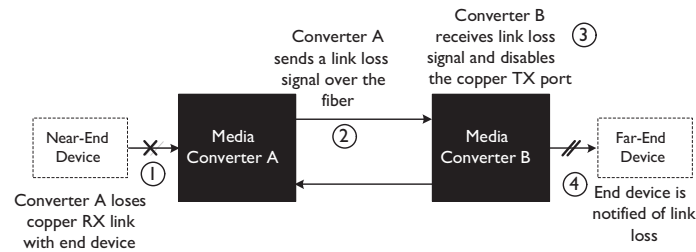

Far-end fault

When a fault occurs on an incoming fiber link (1), the media converter transmits a Far-End Fault signal on the outgoing fiber link (2). In addition, the Far-End Fault signal also activates the Link Pass-Through, which, in turn, disables the link on the copper portion of the network (3) and (4).

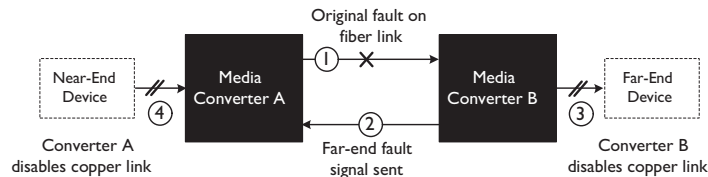

Auto-Negotiation

The Auto-Negotiation feature allows the CSRFB10xx-100 media converter to automatically configure itself to achieve the best possible mode of operation over a link. The media converter will broadcast its speed (*10Mbps or 100Mbps*) and duplex capabilities (*full or half*) to the other converters and negotiates the best mode of operation. Auto-Negotiation allows quick and easy installation because the optimal link is established automatically. No user intervention is required to determine the best mode of operation.

A scenario where the media converter is linked to a non-negotiating converter is a case where the user may want to disable Auto-Negotiation. In this instance, the mode of operation will drop to the least common denominator between the two converters (*e.g. 100 Mbps, half duplex*). Disabling this feature gives the user the ability to force the connection to the best mode of operation.

Operation -- Continued

Product features - continued

Parallel detection

Per the IEEE method, an auto-negotiating port that detects a forced link partner should drop to the detected speed (*10Mbps or 100Mbps*) and default to HALF DUPLEX.

Full duplex network

In a full duplex network, maximum cable lengths are determined by the type of cables that are used. See page 1 (*front cover*) for the cable specifications for the different CSRFB10xx-100 models.

Half duplex network (512-Bit Rule)

In a half duplex network, the maximum cable lengths are determined by the round trip delay limitations of each Fast Ethernet collision domain. (*A collision domain is the longest path between any two terminal converters, e.g. a terminal, switch, or router.*)

The 512-Bit Rule determines the maximum length of cable permitted by calculating the round-trip delay in bit-times (BT) of a particular collision domain. If the result is less than or equal to 512 BT, the path is good. For more information on the 512-Bit Rule, see the white paper titled "Collision Domains" on-line at: www.transition.com.

SNMP

See the on-line documentation that comes with Transition Networks FocalPoint™ software for applicable commands and usage.

Use SNMP at an attached terminal or at a remote location to monitor the media converter by monitoring:

- Media converter power
- Serial and part number
- Port number
- Copper and fiber link status
- Copper and fiber duplex mode
- Copper port speed
- Hardware switch setting
- View terminal converter status
- Set port ingress rate limits of the center side converter

Also, use SNMP to enter network commands that do the following:

- Enable/disable Auto-Negotiation on copper
- Force 10Mbps or 100Mbps on copper
- Force full duplex or half duplex on copper
- Force full duplex or half duplex on fiber
- Enable/disable Transparent Link Pass Through

Operation -- Continued

Product features - continued

Bandwidth allocation

Bandwidth allocation feature is available on the Center located SRFB converter only. The center converter supports independent ingress rate limiting on both the copper and fiber ports. The increments range from 64kps up to full bandwidth. This feature is controlled by a Point System management module installed in a Point System Chassis, along with the SW6 position of the CSRFB converter set to 'center'. The following rates are available for all traffic:

- 64 Kbps
- 128 Kbps
- 256 Kbps
- 512 Kbps
- 1 Mbps
- 2 Mbps
- 4 Mbps
- 8 Mbps
- 16 Mbps
- 32 Mbps
- 64 Mbps
- 72 Mbps
- 80 Mbps
- 88 Mbps
- No Limit

Cable Specifications

The physical characteristics must meet or exceed IEEE 802.3™ specifications.

Fiber cable

Bit Error Rate:	<10-9	
Single mode fiber (<i>recommended</i>):	9 μm	
Multimode fiber (<i>recommended</i>):	62.5/125 μm	
Multimode fiber (<i>optional</i>):	100/140, 85/140, 50/125 μm	
CSRFB1011-100	multimode	
Fiber Optic Transmitter Power:	min: -19.0 dBm	max: -14.0 dBm
Fiber Optic Receiver Sensitivity:	min: -30.0 dBm	max: -14.0 dBm
Link Budget:	11.0 dB	
CSRFB1013-100	multimode	
Fiber Optic Transmitter Power:	min: -19.0 dBm	max: -14.0 dBm
Fiber Optic Receiver Sensitivity:	min: -30.0 dBm	max: -14.0 dBm
Link Budget:	11.0 dB	
CSRFB1014-100	single mode	
Fiber-optic Transmitter Power:	min: -15.0 dBm	max: -8.0 dBm
Fiber-optic Receiver Sensitivity:	min: -31.0 dBm	max: -8.0 dBm
Link Budget:	16.0 dB	
CSRFB1029-100	1310TX/1550	
CSRFB1029-101	1550TX/1310 single mode	
Fiber-optic Transmitter Power:	min: -14.0 dBm	max: -8.0 dBm
Fiber-optic Receiver Sensitivity:	min: -33.0 dBm	max: -3.0 dBm
Link Budget:	19.0 dB	
CSRFB1029-102	1310TX/1550	
CSRFB1029-103	1550TX/1310 single mode	
Fiber-optic Transmitter Power:	min: -8.0 dBm	max: -3.0 dBm
Fiber-optic Receiver Sensitivity:	min: -33.0 dBm	max: -3.0 dBm
Link Budget:	25.0 dB	

Copper cable maximum cable distance: 100 meters

Category 3: (<i>Minimum requirement for 10 Mbps operation</i>)	
Gauge	24 to 22 AWG
Attenuation	11.5 dB/100m @ 5-10 MHz
Category 5: (<i>Minimum requirement for 100 Mbps operation</i>)	
Gauge	24 to 22 AWG
Attenuation	22.0 dB /100m @ 100 MHz

- Straight-through (MDI) or crossover (MDI-X) twisted-pair cable must be used.
- Shielded twisted-pair (STP) or unshielded twisted-pair (UTP) may be used.
- Pins 1&2 and 3&6 are the two active pairs in an Ethernet network .
- Use only dedicated wire pairs for the active pins:
(*e.g., blue/white & white/blue, orange/white & white/orange, etc.*)
- Do not use flat or silver satin wire.

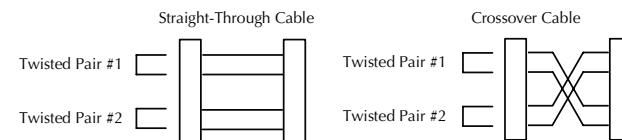

Technical Specifications

For use with Transition Networks Model CSRFB10xx-100 or equivalent.

Standards	IEEE 802.3™
Data Rate:	10 Mbps, 100 Mbps
Dimensions	3.4" x 5" x 1" (86 mm x 127 mm x 25.4 mm)
Weight	4 oz. (114 g approximate)
Power Consumption:	3.0 W
MTBF	280,232 MIL-HDBK-217F Hours 770,637 Bellcore Hours
Packet Size:	Unicast MAC address: 1K Maximum packet size: - 1916 bytes untagged bytes - 1912 bytes tagged bytes
Environment	Tmra*: 0 to 50°C (32 to 122°F) Storage Temp: -25 to 65°C (-13 to 149°F) Humidity 5 to 95%, non condensing
Warranty	Lifetime

*Manufacturer's rated ambient temperature: Tmra range for this slide-in-module depends on the physical characteristics and the installation configuration of the Transition Networks PointSystem™ chassis in which this slide-in-module will be installed.

The information in this user's guide is subject to change. For the most up-to-date information on the CSRFB10xx-100 media converter, view the user's guide on-line at: www.transition.com.

Product is certified by the manufacturer to comply with DHHS Rule 21/CFR, Subchapter J applicable at the date of manufacture.

CAUTION: Visible and invisible laser radiation when open. Do not stare into beam or view directly with optical instruments.

CAUTION: Use of controls, adjustments or the performance of procedures other than those specified herein may result in hazardous radiation exposure.

The fiber optic transmitters on this converter meet Class I Laser safety requirements per IEC-825/CDRH standards and comply with 21 CFR1040.10 and 21CFR1040.11.

Troubleshooting

If the media converter fails, isolate and correct the failure by determining the answers to the following questions and then taking the indicated action:

- Is the PWR (*power*) LED illuminated?
NO
 - Is the media converter inserted properly into the chassis?
 - Is the power cord properly installed in the chassis and at the external power source and does the external power source provide power?
 - Contact Technical Support: US/Canada: 1-800-260-1312, International: 00-1-952-941-7600.
 YES
 - Proceed to step 2.
- Is the Link/Activity (*twisted-pair link*) LED illuminated?
NO
 - Check the copper cables for proper connection and pin assignment.
 - Contact Technical Support: US/Canada: 1-800-260-1312, International: 00-1-952-941-7600.
 YES
 - Proceed to step 3.
- Is the LACT (*fiber-pair link*) LED illuminated?
NO
 - Check the fiber cables for proper connection.
 - Verify that the TX and RX cables are connected to the RX and TX ports, respectively, on the 100Base-FX converter.
 - Contact Technical Support: US/Canada: 1-800-260-1312, International: 00-1-952-941-7600.
 YES
 - Proceed to step 4.
- Is the Speed (*twisted-pair speed*) LED illuminated?
NO
 - Check the copper cables for proper connection.
 - Off = The media converter has selected 10Mbps operation.
 - If the speed is not correct, disconnect and reconnect the twisted pair cable to restart the initialization process.
 - Contact Technical Support: US/Canada: 1-800-260-1312, International: 00-1-952-941-7600.
 YES
 - On = The media converter has selected 100Mbps operation.
 - If the speed is not correct, disconnect and reconnect the twisted pair cable to restart the initialization process.
 - Contact Technical Support: US/Canada: 1-800-260-1312, International: 00-1-952-941-7600.

Installation -- Continued

4. Is remote converter detected?
 NO
- Check for proper connection from the terminal converter to center converter.
 - Check the center/terminal switch setting on both converters: (*center converter switch set to 'center,' the terminal converter switch set to 'terminal.'*) .
 - Contact Technical Support: US/Canada: 1-800-260-1312, International: 00-1-952-941-7600.
- YES
- Contact Technical Support: US/Canada: 1-800-260-1312, International: 00-1-952-941-7600.

Contact Us

Technical support

Technical support is available 24 hours a day.
 US and Canada: 1-800-260-1312
 International: 00-1-952-941-7600

Transition now

Chat live via the Web with Transition Networks Technical Support. Log onto www.transition.com and click the Transition Now link.

Web-Based seminars



Transition Networks provides seminars via live web-based training. Log onto www.transition.com and click the Learning Center link.

E-Mail

Ask a question anytime by sending an e-mail to our technical support staff. techsupport@transition.com

Address

Transition Networks
 10900, Red Circle Drive, Minnetonka MN 55343, U.S.A.
 telephone: 952-941-7600, toll free: 800-526-9267, fax: 952-941-2322

	Declaration of Conformity
Name of Mfg: Transition Networks 10900 Red Circle Drive, Minnetonka MN 55343 U.S.A.	
Model: CSRFB10xx-100 Series Media Converters	
Part Number(s): CSRFB1011-100, CSRFB1013-100, CSRFB1014-100, CSRFB1029-100, CSRFB1029-10, CSRFB1029-102, CSRFB1029-103, CSRFB1040-100	
Regulation: EMC Directive 89/336/EEC	
Purpose: To declare that the CSRFB10xx-100 to which this declaration refers is in conformity with the following standards. EMC-CISPR 22:1985 Class A; EN 55022:1998 Class A; FCC Part 15 subpart B; 22 CFR subpart J	
I, the undersigned, hereby declare that the equipment specified above conforms to the above Directive(s) and Standard(s).	
 Stephen Anderson, Vice-President of Engineering	April 2009 _____ Date

Compliance Information

CISPR22/EN55022 Class A, EN55024

CE Mark

FCC regulations

This equipment has been tested and found to comply with the limits for a Class A digital converter, pursuant to part 15 of the FCC rules. These limits are designed to provide reasonable protection against harmful interference when the equipment is operated in a commercial environment. This equipment generates, uses, and can radiate radio frequency energy and, if not installed and used in accordance with the instruction manual, may cause harmful interference to radio communications. Operation of this equipment in a residential area is likely to cause harmful interference, in which case the user will be required to correct the interference at the user's own expense.

Canadian regulations

This digital apparatus does not exceed the Class A limits for radio noise for digital apparatus set out on the radio interference regulations of the Canadian Department of Communications.
Le présent appareil numérique n'émet pas de bruits radioélectriques dépassant les limites applicables aux appareils numériques de la Class A prescrites dans le Règlement sur le brouillage radioélectrique édicté par le ministère des Communications du Canada.

European regulations

Warning This is a Class A product. In a domestic environment this product may cause radio interference in which case the user may be required to take adequate measures.

Achtung! Dieses ist ein Gerät der Funkstörgrenzwertklasse A. In Wohnbereichen können bei Betrieb dieses Gerätes Rundfunkstörungen auftreten. In diesem Fall ist der Benutzer für Gegenmaßnahmen verantwortlich.

Attention! Ceci est un produit de Classe A. Dans un environnement domestique, ce produit risque de créer des interférences radioélectriques, il appartiendra alors à l'utilisateur de prendre les mesures spécifiques appropriées.



CAUTION: RJ connectors are NOT INTENDED FOR CONNECTION TO THE PUBLIC TELEPHONE NETWORK. Failure to observe this caution could result in damage to the public telephone network.

Der Anschluss dieses Gerätes an ein öffentliches Telekommunikationsnetz in den EG-Mitgliedstaaten verstösst gegen die jeweiligen einzelstaatlichen Gesetze zur Anwendung der Richtlinie 91/263/EWG zur Angleichung der Rechtsvorschriften der Mitgliedstaaten über Telekommunikationsendeinrichtungen einschliesslich der gegenseitigen Anerkennung ihrer Konformität.



In accordance with European Union Directive 2002/96/EC of the European Parliament and of the Council of 27 January 2003, Transition Networks will accept post usage returns of this product for proper disposal. The contact information for this activity can be found in the 'Contact Us' portion of this document.

Trademark notice

All trademarks and registered trademarks are the property of their respective owners.

Copyright restrictions

© 2005 Transition Networks.

All rights reserved. No part of this work may be reproduced or used in any form or by any means - graphic, electronic, or mechanical - without written permission from Transition Networks.